

A^{RF34} UART TTL modules



User Guide

No part of this document may be reproduced or transmitted (in electronic or paper version, photocopy) without Adeunis RF consent.

This document is subject to change without notice.

All trademarks mentioned in this guide are the property of their respective owner.

ADEUNIS RF

283, rue Louis Néel

38920 Crolles

France

Phone +33 (0)4 76 92 07 77

Fax +33 (0)4 76 08 97 46

Ref. 08-07-V13-Imn

Table of Contents

About this Document	2
Declaration of Conformity	3
Download of the user guide	3
Overview	1
Interface	2
Mechanical specification.....	2
Signal description	4
Radio communication	5
Radio channel	6
Channel selection	8
Radio rate selection.....	9
Channel rejection	9
Antenna requirements	10
RSSI reading.....	10
Transceiver operating mode	11
Command mode.....	11
Transceiver mode.....	12
Power management (standby mode and low power mode)	14
AT Commands	15
Description	15
Set of commands	15
Register description.....	17
General purpose I/O extended functionality	22
Transceiver state machine	24
Specifications	26
Glossary	28
ANNEX 1 : Streaming mode	29
ANNEX 2 : Integrated antenna Irradiation diagram	30
ANNEX 3 : Alternative mounting	32
ANNEX 4 : Firmware updates	33

About this Document

This guide describes the A^{RF34} devices, their options and accessories.

Declaration of Conformity



Manufacturer's name:
Manufacturer's address

ADEUNIS R.F.
Parc Technologique PRE ROUX IV
283 rue Louis NEEL
38920 CROLLES - FRANCE

declares that the product if used and installed according to the user guide available on our web site www.adeunis-rf.com

Product Name: **ARF34**

Product Number(s): **ARF7151A / ARF7151B**

is designed to comply with the RTTE Directive 99/5/EC:

EMC: according to the harmonized standard EN 301 489.

Safety: according to the standard EN 60950-1/2001

Radio: according to harmonized standard EN 300-220 covering essential radio requirements of the RTTE directive.

Notes: - Conformity has been evaluated according to the procedure described in Annex III of the RTTE directive.

- Receiver class (if applicable): 3.

According to the 1999/519/EC recommendation, minimum distance between the product and the body could be required depending on the module integration.

Warnings: - CE marking applies only to End Products: Because this equipment is only a subassembly, conformity testing has been reduced (equipment has been design in accordance to standards but full testing is impossible). Manufacturer of End Products, based on such a solution, has to insure full conformity to be able to CE label marking.

- As the integration of a radio module requires wireless technological knowledge, ADEUNIS RF proposes its technical proficiency to its customers for a pre-compliance qualification of end products. In case of no-conformity, ADEUNIS RF will not be held back responsible if this stage has not been realised.

Crolles, November 6th, 2007
VINCENT Hervé / Quality manager

Download of the user guide

Thank you for having chosen the ADEUNIS RF products.

User guides can be uploaded directly on our web site www.adeunis-rf.com

Index **Products**

Paragraph **OEM Modules > UART TTL Transceivers**

Print version available upon request

✓ Tel : +33 4 76 92 07 77

✓ Email : arf@adeunis-rf.com

Overview

The A^{RF34} radio transceiver converts data from a serial link into a radio frame to be sent to a similar piece of equipment. The communication is half-duplex.

The operating parameters of these radio transceivers (serial link, radio management...) can be fully updated through AT commands via the serial link.

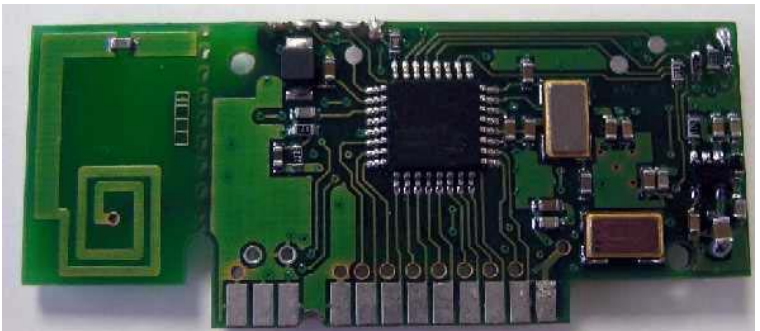

CAUTION

Some features are not currently available or are still under evaluation. These features are marked as N/A (Note Available); when needed, an explanation is given on the current status of the feature (explanation highlighted in Yellow)

Interface

Mechanical specification

The transceiver is available in two formats :

1. Plugged module with (printed antenna).
2. Plugged module without (the integrated antenna area is removed)

The PCB width is 12/10 mm

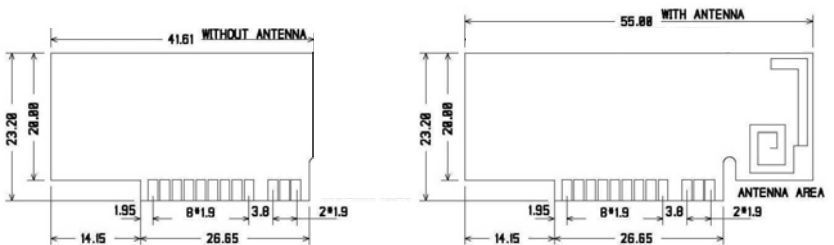
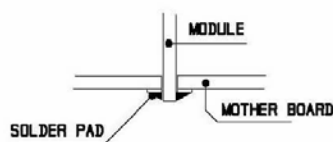
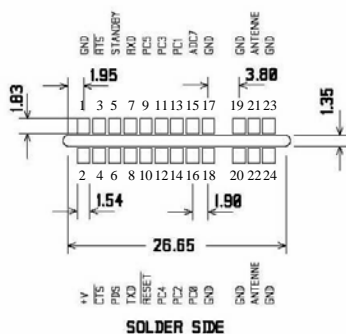
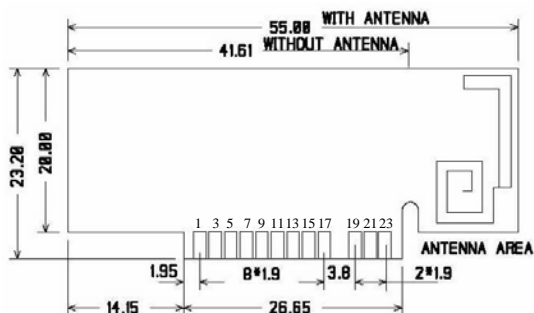

Figure 1: Two PCB formats



UNIT : MILLIMETER

Figure 2: Plugged module mechanical feature

This module is designed to be plugged (as describe above). If this assembly doesn't suited your requirement see Annex 3 (mainly for horizontal mounting).

Signal description

Inter- face Pin	Name	I/O	Description	Alternate function
			Digital interface	
1	GND		Ground	
2	VDD		Operating voltage	
8	TXD	O	Serial data transmission	
7	RXD	I	Serial data reception	
3	/RTS	O	Request To Send RTS = GND, the transceiver is able to receive serial data RTS = VDD, serial data received by the transceiver are lost	
4	/CTS	I	NC	
10	/RESET	I	Transceiver Hardware RESET, active LOW.	
5	PWD	I	Power down management	
16	GPIO1 / PC0	I/O	Extended general purpose I/O	
13	GPIO2 / PC1	I/O	Extended general purpose I/O	RS485
14	GPIO3 / PC2	I/O	Extended general purpose I/O	
11	GPIO4 / PC3	I/O	Extended general purpose I/O	RS485
12	GPIO5 / PC4	I/O	Extended general purpose I/O	RS485
9	GPIO6 / PC5	I/O	Extended general purpose I/O	
6	GPIO7 / PD5	I/O	Extended general purpose I/O	RS485
15	GPIO8 / ADC7	ADC	Analogic to digital conversion	
17, 18	GND		Ground	
			RF interface	
19, 20	GND RF		RF antenna ground	
21, 22	RF in/out		RF antenna IN/OUT.	
23, 24	GND RF		RF antenna ground.	

Radio communication

This modem has several channels over the 863-870 MHz Band that can be selected using AT commands, distributed in Wide Band and Narrow Band.

Wide Band channel :

- 14 Wide Band channels (first set of channels from 0 up to 13)
- 57,6 kbit/s radio rate
- channel spacing: 500 kHz
- Sensitivity : - 103 dBm
- Adjacent channel rejection: see chapt. [Channel rejection](#)
-

Narrow Band channel :

- 70 Narrow Band channels (second set of channels from 14 up to 83)
- 10 kbit/s radio rate
- channel spacing: 100 kHz
- Sensitivity : - 105 dBm
- Adjacent channel rejection: see chapt. [Channel rejection](#)

This module is designed to operate according to CEPT/ERC/REC 70-03 recommendation. This recommendation has been drawn up by the European Radio communications Committee (ERC) under CEPT.

A new frequency allocation in Europe, for the 863 to 870 MHz band, is in progress. When this new frequency allocation has been approved, the proposed 863-870 channels should be used according to these new recommendations.

NOTE

The RF out power could be adjusted using AT commands (see register S231).

Radio channel

The 14 Wide Band channels are selected according to the following table :

Channel S200	Frequency (MHz)
13	863,25
12	863,75
11	864,25
10	864,75
9	865,25
8	865,75
7	866,25
6	866,75
5	867,25
4	867,75
3	868,25
2	868,75
1	869,525
0	869,75

Figure 3: Wide band channels

The 70 Narrow Band channels are selected according to the following table:

Channel S200	Frequency (MHz)	Channel S200	Frequency (MHz)	Channel S200	Frequency (MHz)
83	863,05	60	865,35	37	867,65
82	863,15	59	865,45	36	867,75
81	863,25	58	865,55	35	867,85
80	863,35	57	865,65	34	867,95
79	863,45	56	865,75	33	868,05
78	863,55	55	865,85	32	868,15
77	863,65	54	865,95	31	868,25
76	863,75	53	866,05	30	868,35
75	863,85	52	866,15	29	868,45
74	863,95	51	866,25	28	868,55
73	864,05	50	866,35	27	868,65
72	864,15	49	866,45	26	868,75
71	864,25	48	866,55	25	868,85
70	864,35	47	866,65	24	868,95
69	864,45	46	866,75	23	869,05
68	864,55	45	866,85	22	869,15
67	864,65	44	866,95	21	869,25
66	864,75	43	867,05	20	869,35
65	864,85	42	867,15	19	869,45
64	864,95	41	867,25	18	869,55
63	865,05	40	867,35	17	869,65
62	865,15	39	867,45	16	869,75
61	865,25	38	867,55	15	869,85
				14	869,95

Figure 4: Narrow Band channels

Currently and according to CEPT/ERC/REC 70-03 recommendation, the authorised channels are :

- For the WB, limited to 25 mW according to above recommendation(up to 25 mW for A^{RF34} module) : channels 2 (868.75) and 3 (868.25)
- For the WB, limited to 500 mW according to above recommendation (up to 50 mW for A^{RF34} module) : channel 1 (869.525)
- For the NB, limited to 25mW according to above recommendation(up to 25 mW for A^{RF34} module) : channels 22 (869.15), 23 (869.05), 24 (868.95), 25 (868.85), 26 (868.75), 28 (868.55), 29 (868.45), 30 (868.35), 31 (868.25), 32 (868.15), 33 (868.05)
- For the NB, limited to 500 mW according to above recommendation (up to 50 mW for A^{RF34} module) : channels 18 (869.55), 19 (869.45).
- Figures between brackets are expressed in MHz.

Channel selection

The S200 register allows choosing the desired channel. When the S200 channel register is written (even with the same value) or set to its default value (see ATR command), the on-chip radio parameters must be updated and a radio-chip calibration is required.

These update and calibration take up to 90 ms (nominally 30ms); during this time the transceiver is not able to receive or transmit any data → all incoming RS232 data will be ignored (silently discarded).

This update and calibration is performed:

- when leaving the command mode (issuing ATO command)
- or when an ATTx command is issued.

This is done for insuring that the radio chip is working with the appropriate configuration.

Radio rate selection

For 868 / 870 MHz version, the Radio rate selection is automatically done when setting the channel number:

If you choose a channel number ≥ 14 (Narrow Band), the radio rate will automatically switch to 10 kbit/s.

If you choose a channel number < 14 , the module will operate in the Wide Band configuration. The radio rate will switch automatically to 57600 bit/s.

Channel rejection

The graph below shows the typical channels rejection of A^{RF34} in WideBand (WB) and NarrowBand (NB) modes.

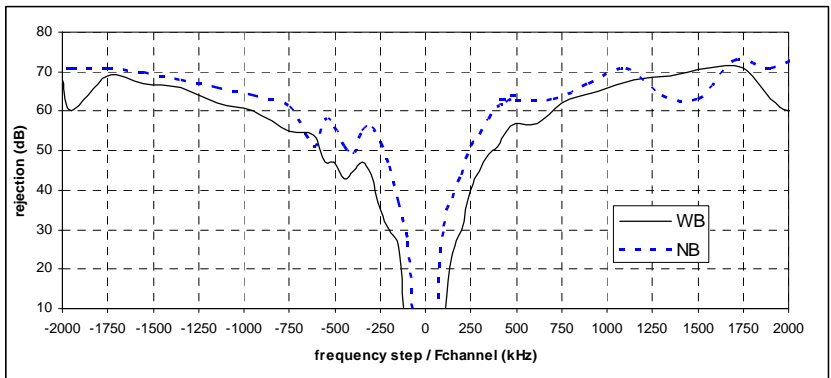

TAKE CARE

Particular attention is required for product installation. In the case where several links must work in the same area (no matter the channel positions), the minimum distance between 2 A^{RF34} belonging to different radio links is 3 meters. Even with this precaution (depending on the product environment), channel rejection could be reduced.

Antenna requirements

Printed antenna

When ordered with the printed antenna, the module is plug-and-play: the printed antenna is directly connected to the RF in/out of the module. With this version, RFin_out pin must remain unused (unconnected).

The printed antenna is reserved for application with a short range between products. For longer distance, the use of external antenna is recommended.

External antenna

If you are not using the printed antenna, an antenna has to be added to achieve correct communication between the products. Several possibilities:

- The best technical/economical compromise is a $\frac{1}{4}$ wave (8.6 cm length) antenna soldered on the “mother board”. The link between the RFin_out pin of the module and the antenna should be a 50Ω line. The larger the ground plane around the antenna, the more efficient and “isotropic” it will be.
- If necessary, this antenna can be distant thanks to a coaxial cable connected to the “mother board”; the line must be a 50Ω line.

RSSI reading

The RSSI (Received Strength Signal Indicator) gives an indication for the received power level.

It could be accessed with AT commands.

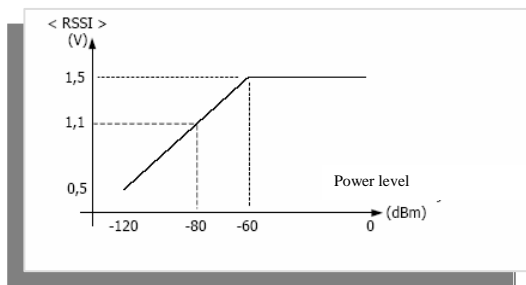

The RSSI level is only an indication. Use this level with care due to the dispersion between components.

The schema above could be modified from one to another product. The operating temperature could also have an impact on these dispersions.

The RSSI level could also indicate the potential presence of jammer in the used channel.

The RSSI is a necessary but not sufficient condition to obtain a correct reception.

Transceiver operating mode

Two operating modes are available :

1. Command mode (usage of AT commands)
2. Transceiver or normal mode (serial data are transmitted on radio link)

At power up the transceiver is in transceiver mode: it is able to send / receive data to / from the radio link according to its current parameter configuration.

Command mode

The command mode is used to read and update the modem configuration registers using AT command.

NOTE

The AT command can be locked using ATPWD command.

In command mode, the radio is inhibited (reception and transmission), excepted when using test command.

Entering command mode : issues on the serial link a +++ sequence. The sequence of 3 consecutive + characters is accepted only if no character have been seen before and after the +++ sequence. Register (S214) defines the silence duration.

Tips 1: if you are using a terminal (such as Hyperterm), you have to send the +++ sequence using a text file (first create a text file containing only the +++ characters, and then use in Hyperterm the command "Send text file" in the "Transfer menu")

Tips 2 :

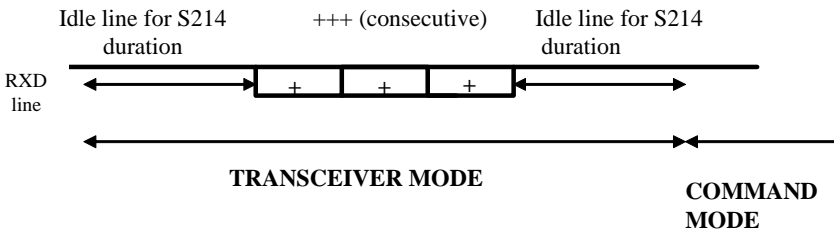

Exiting command mode (return back in transceiver mode): send the serial command

`ATO <cr>`

Transceiver mode

In transceiver mode, two protocols are available:

1. Transparent mode, without flow control. When transmitting, data received from the serial link are transmitted on the radio link. When data are received on the radio link, these data are sent on the serial link.
2. Addressed mode, with flow control (see register S216)

The communication is always half-duplex. The radio transmission is processed prior to the radio reception (when the transceiver is sending a radio frame, it is not able to decode any incoming radio frame).

If no data are sent on the serial link, the modem is waiting for radio reception. Each radio frame sent by another modem is received and the validated data extracted from the radio frame are sent on the serial link. All the data received on the serial link are encapsulated in a radio frame. The radio frame format depends on the used protocol.

When acting as transceiver, the radio frame transmission always starts under the following conditions :

- Detection of a silence on the serial link (greater than S217) after the reception of the latest character.
- Or when the number of received characters from the serial link is higher or equal to the maximum radio frame size (S218).
-

Transparent mode

In transparent mode, the modem acts as a wire serial link. It means that alternately, the modem sends on the radio the data received from the serial link and sends on the serial link the data received from the radio.

The radio frame format is :

- <Preamble><synchro>DATA <postambule>.
Preamble, synchronisation and postambule are used for the radio reception.

Addressed mode

In transmission mode, data received on the serial link are sent on the radio link with the following format :

- <Preamble><synchro><Address> DATA <postambule>.
Preamble, synchronisation and postambule are used for the radio reception.
- The Address field is set up with S256 value (LSB first).

In reception mode : The <Address> field of the radio frame is checked with the reception address (S252)

- If the radio frame address matches the transceiver reception address (S252), DATA (and only DATA) are transmitted on the serial link
- otherwise received data are silently discarded.

Power management (standby mode and low power mode)

Two modes are available for power management :

1. A standby mode, with a short wake-up time.
2. A low power consumption mode with a longer wake-up time (including supply stabilisation and radio calibration)

	Standby mode	Low power consumption mode
Entered	<p>When: in command mode</p> <p>How: set S232 register to 1, issuing the AT command</p> <p style="text-align: center;"><code>ATS232=1<cr></code></p>	<p>When: in transceiver mode</p> <p>How: a high level (or pin left unconnected) on the PWD signal puts the module in low power mode</p> <p>Condition: the low power mode consumption must be enabled (see hereafter)</p>
Exited	<p>How: when receiving the following string</p> <p style="text-align: center;"><code>ATS232=0</code></p> <p>State after wake up : transceiver mode</p>	<p>How: a low level on PWD signal wakes up the device</p> <p>State after wake up : transceiver mode</p>
Consumption	≤ 4 mA	≤ 20 µA
Wake-up time	< 100 µs	50 ms

Enable Low Power down mode :

- The low power down mode is managed only after its activation. Applying a High level on the PWD signal when the mode has not been activated has no effect → the module is still running in its current mode.
- In command mode, send the AT command `ATS232=2<cr>`. After this, a High level applied on PWD signal during transceiver mode allows the module to enter the low power consumption mode.

Disable Low Power down mode:

- In command mode, enter the AT command `ATS232=0<cr>`

AT Commands

Description

AT commands are interpreted only when the transceiver is in Command mode.

Command : are used to read and update the modem parameters

- A command starts with the 2 ASCII 'AT' characters. 'AT' means 'Attention' follow with one or several characters or other data.
- Each command is ended with <cr> (carriage return).
- In the same command, the time between 2 characters must be less than 10s.

Response: is sent back for each command on the serial link. The answer is :

- 'O'<cr> (ASCII character 0x4F) for accepted command (or OK command)
- 'E'<cr> for error
- Specific string when specified

Set of commands

Commands	Description
	<u>Operating mode selection</u>
<silence>+++<silence>	Command mode activation. The +++ sequence must be preceded and followed by a calibrated silence (no other character)

Commands	Description
ATO	Return back to transceiver mode.
	<u>Registers management</u>
ATSn?	Displays the Sn register content where n represents the register number. The response has the following format: Sn=y<cr><lf>
ATSn=m	Sets the Sn register value with 'm'. n represents the register number..
AT&W	Saves the new register configuration in EEPROM. Each time you switch on the modem, the EEPROM configuration will be loaded in the modem registers.
AT/S	Displays all register values. The response has the following format: Sxxx=y<cr><lf> for each register.
AT/V	Software version display. The response has the following format: Adeunis RF : A ^{RF34} Vxx.yy<cr><lf>
ATR	Restore the register default values
ATPWD=m	m = pin code (register S205) : unlock all AT commands. m = 0000 : set registers to default value and unlock all AT commands.
	<u>Test modes</u>
ATT1	Pure Carrier (data=0) transmission using current channel. The output of this mode is achieved by reception of any character on the serial link.
ATT2	Pure Carrier (data=1) transmission using current channel. The output of this mode is achieved by reception of any character on the serial link.
ATT3-ATT6	Modulation using current channel. The output of this mode is achieved by reception of any character on the serial link. ATT3: 0.9 KHz modulation ATT4: 3.6 KHz modulation ATT5: 14.4 KHz modulation ATT6: 28.8 KHz modulation

AT/S is not available for baud rate lower than 2400 bauds

Register description

The register value could be updated using the `ATSn=m<cr>` command and displayed using `ATSn?<cr>` command.

At power-up, the previous transceiver configuration is restored from E2PROM (non volatile) to RAM. The registers are located in RAM registers, any modification is performed on RAM registers: To save current register configurations, it is necessary to use the `AT&W<cr>` command (If not, the updated parameters are lost in case of power shortage).

The registers are shared in 2 types: read only (R) or read/write (R/W)

Type	Register	Function	Description	Default value	Note
			Radio management		
R/W	S200	Channel number	Radio channel for 868 / 870 MHz version : From '0' up to '13', Wide Band channel. From '14' up to '83', Narrow Band channel. Radio channel for 915 MHz version : From '0' up to '25', Wide Band channel.	1	3
R/W	S201	Radio rate (for wide band only)	Wide band radio rate selection 0: 57 600 bit/s (recommended) 1: 38 400 bit/s	0	2,3

Type	Register	Function	Description	Default value	Note
R/W	S202	Command mode, auto-exit	Automatic command mode exit 0 : (no specific management), the command mode will be exited only when an ATO command is issued. From 1 to 60 : timeout in second. → If no activity (no character, command reception) is detected in command mode for the programmed timeout, the command mode will be exited. The module is back to transceiver mode	0	
R/W	S204	Preamble duration	Preamble duration, unit ms From 3 up to 50	3	4
R/W	S217	Serial timeout for radio	Serial timeout before starting radio transmission, unit ms. From 3 up to 240.	3	1
R/W	S218	Radio frame length	Size of the radio frame (from 1 up to 240). When this size is reached: 1. the transceiver sends a radio frame 2. The RTS signal is activated (pull to VDD) only if the module is operating in the addressed mode.	128	
R	S230	RSSI level	Displays the reception level of the latest received message. Response: S230=-xxx dBm<cr><lf> with xxx decimal value The RSSI values range from – 115 up to –60 dBm.	None	

Type	Register	Function	Description	Default value	Note
R/W	S231	RF OUT level	Adjusts the RF out level 868 / 870 MHz version : 0 => 10 dBm (10 mW) 1 => 14 dBm (25 mW) 2 => 17 dBm (50 mW)	2	
			Serial link		
R/W	S210	Baudrate	Serial link rate in bits/s '0': 600 '1': 1 200 '2': 2 400 '3': 4 800 '4': 9 600 '5': 19 200 '6': 38 400 '7': 57 600 '8': 115 200	4	1,2,6
R/W	S211	Data length	'7' : 7 bits '8' : 8 bits	8	6
R/W	S212	Parity	'1' : none '2' : even '3' : odd	1	6
R/W	S213	Stop bits	'1' : 1 stop bit '2' : 2 stop bit	1	6
R/W	S214	Command timeout	Time out duration for detecting the +++ pattern, unit ms. From 3 up to 240.	3	1
R/W	S215	Interface type	'0' : RS232 only '1' : RS232 or RS485 (managed DE/RE lines) (RS485 if pin 6 tied to ground)	1	
R/W	S216	Handshake	'0' : hardware, RTS (restricted to addressed protocol) '2' : none	2	

Type	Register	Function	Description	Default value	Note
R/W	S219	RS485 delay	Delay between DE activation and the first RS485 transmitted byte From 0 up to 160	3	
			Protocol		
R/W	S220	Protocol	'1'= transparent mode '6'= addressed	6	
R/W	S252	Reception address	From 0 up to FFFF Used in addressed protocol only, for filtering incoming frame		
R/W	S256	Transmission address	From 0 up to FFFF Used in addressed protocol only, added to outgoing frame		
			Miscellaneous		
R/W	S205	Pin code	Pin code value Value 0000 is not allowed	1111	
R/W	S207	Pin code activation	0 pin code disabled 1 pin code enabled	0	
R/W	S232	Power management	0 disable modes 1 immediately enter standby mode 2 enable low power down mode	0	5

NOTE 1

when a serial speed change is requested, the S214 and S217 registers values are automatically set to a value greater or equal than the duration of three characters in the requested speed (13 ms for 2400 bauds, 7 ms for 4800, 3 ms otherwise).

NOTE 2

streaming mode without flow control. Be careful → using a serial rate greater to the radio rate must produce character losses if the flow control is not used. If the radio rate is equal to the serial rate, the radio frame is longer than the serial frame, due to radio protocol overhead; but the radio overhead will be generated only when the radio transmission begins → this overhead will be absorbed by internal buffer size.

For example, if the current radio rate is 57 600 kbit/s, a serial rate of 57 600 should be used without flow control, while using a serial rate of 115 200 (with 57 600 for the radio rate) will produce data overrun.

For avoiding character losts, you should

1. use the flow control (addressed mode with hardware handshake)
2. or use a serial rate lower or equal to the radio rate
3. or limit the size of serial data to the maximum size of the internal buffer (S218).

NOTE 3

(S200 register) see chapt. [Radio channel](#) and chapt. [Channel](#)

NOTE 4

The preamble duration is linked to the current radio rate. For high speed radio rate (Wide Band) the preamble duration is adjusted to 3ms while for low speed rate (Narrow Band) the preamble duration is adjusted to 6ms.

The minimum preamble values are

	Minimum preamble value
WB channel (high radio rate)	3 ms
NB channel (low radio rate)	6 ms

In NB configuration the S204 register value could be set to a value lower than 6ms. In this case, the module prevents using this incorrect preamble length with an automatic adjustment to 6ms.

NOTE 5

(S232 register) see chapt. [Power management \(standby mode and low power mode\)](#)

NOTE 6

when changing the serial link configuration (rate, parity, stop bit...), the answer is done using the old serial link format, the next command must be sent using the new serial format.

General purpose I/O extended functionality

RS485 interface

The S215 register allows enabling the management of the control lines (/RE and DE lines) of most RS485 buffer. The following figures illustrate the RS485 wiring and the configuration required for activating the DE and /RE management. Even one line is sufficient, for more flexibility two different lines could managed the DE and RE RS485 control lines. Hereafter a connection example with both lines or one line only.

RS485 control lines managed with two different control lines

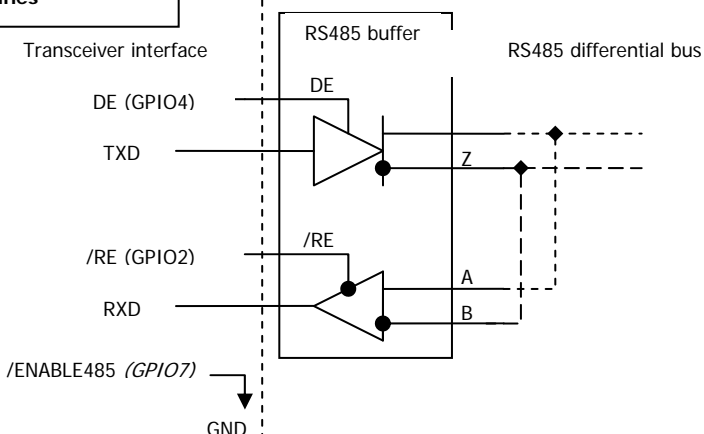

Configuration required : S215 = 1 and ENABLE485 (GPIO7) tied to GND

RS485 control lines managed
with only one control line

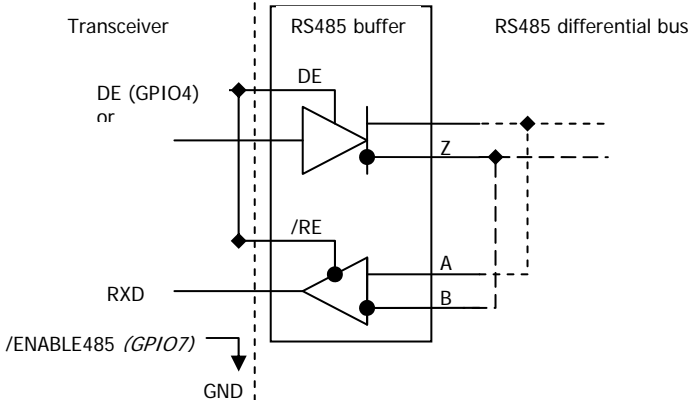

Configuration required : S215 = 1 and ENABLE485 (GPIO7) tied to GND

CAUTION

the /ENABLE485 is read **ONLY at power-up**. Changing the /ENABLE485 (GPIO7) when the transceiver is already running will not be taken in account.

CAUTION

when activating the RS485 interface the GPIO5 will be set as an output.

S215 Value	/ENABLE485 (GPIO7)	DE/RE state	Note	GPI O2	GPI O4	GPI O5	GPI O7
1	GND	Output	RS485 control lines management	Output	Output	Output	Input
1	VDD	Input	RS232 configuration	Input	Input	Input	Input
0	Input	Input	RS232 configuration	Input	Input	Input	Input

Table 1: R485/232 configuration settings

By default, the DE and RE lines are asserted LOW, allowing the reception of characters from the RS485 differential bus. The DE and RE lines are asserted HIGH only when one or several characters have to be transmitted over the RS485 differential bus: when a radio frame is demodulated, the lines are asserted HIGH and then the data extracted from the radio frame are sent to the module TXD line and therefore to the RS485 differential bus. When the last character has been transmitted over the RS485 differential bus, the lines are asserted LOW.

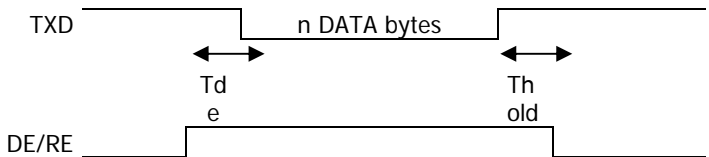

Figure 5: DE/RE timing when data are sent over the serial link

Thold : minimum = 1 μ s

Tde : set according to the S219 register value (see table hereafter)

S219	0	1	2	3	4	5	10	20	40	60	80
Tde min	20	40	60	80	100	110	250	480	900	1.3	1.7
	μ s	μ s	μ s	μ s	μ s	μ s	μ s	μ s	μ s	ms	ms

Transceiver state machine

When operating in transceiver mode the 'RF transmission' state machine is :

Idle state of the transceiver: by default the transceiver is waiting for incoming data on the RS232 link and for incoming radio frame on the radio link.

The RS232 link has a higher priority than the radio link (if a radio frame is

demodulated meanwhile some RS232 characters are detected on the serial link, the radio frame will be discarded and the RS232 incoming data will be processed).

Processing incoming RS232 data_: the incoming RS232 data are internally buffered. The buffered data are **sent in a radio frame** (the RF modulation is started) when almost one of the following conditions occurs :

- if a break (silence greater than S217 timeout) is detected on the incoming serial flow (no more data to be sent).
- if the radio buffer size is reached (the number of buffered characters are equal or greater than the S218 size).

Processing incoming radio frame: the valid data are extracted from the incoming radio frame and internally buffered. The buffered data are sent on the fly to the RS232 module output. The internal buffer is limited to 256 bytes.

Specifications

	868 / 870 MHz version
Embedded protocol	ADEUNIS RF enhanced & versatile
Embedded profiles	RF comms manager
Custom profiles	Multi-mode transceiver
	Designed on custom specifications
Link set-up and status	Through Hayes commands
Radio rough data rate	From 9 600 up to 57 600 bps
UART programmable format	Serial rate from 600 bps to 115 kbps
UART TTL ports	TXD – RXD – RTS – CTS or RS485 driving capability
Transceiver multi-modes	Transparent or Addressed
Programmable Frequency	863 to 870 MHz / Europe
Channelization	Adjusted to improve sensitivity (wide and narrow band)
Programmable Radiated RF power	Up to 50 mW (17 dBm)
Sensitivity	Down to –105 dBm for 10 ⁻³ /PN9
Operating range (free field)	Integrated antenna : recommended 100m, up to 500m
	External antenna : up to 1000 m

RSSI level	RF signal qualification	
Operating voltage	Regulated 3.3V nominal 3.6 V)	(3.0 to
TX / RX consumption (max)	100 mA / 35 mA	
Power Down current	< 20 μ A	
Operating temperature	-20°C / +70°C	
Dimensions	55 x 20 x 4 mm	
Standards compliance	EN 300-220 / EN 301 489	

References

**ARF7151A : Plugged module with integrated antenna ARF7151B :
Plugged module without antenna**

Glossary

TBD	To Be Defined
NC	Not Connected
NU	Not Used
WB	Wide Band
NB	Narrow Band

ANNEX 1 : Streaming mode

The following timing illustrates a streaming mode that could be implemented with the A^{RF34} transceiver (using the transparent mode):

- As depicted, the streaming mode is obtained when using a serial rate equivalent to the radio rate.
- Other rates combination could be used with care → performing this will induce some limitations that must be taken into account by the user (for example using a serial rate higher than the radio rate is possible ONLY if the serial frame length is limited).

The figures in the table have been measured using two radio rates: 10 kbit and a 38400 bit/s.

The specific parameter configuration is mentioned.

S204 Pream ble length	S210 Serial rate	Radio rate	S218 Start RF frame	T transfer (second)	Effec- tive baud rate	T start	T pro- pag.	T rf (se- cond)	TM1	Nb data sent
4	4 / 9600	10 K	1	1.08	9481	1.3 ms	7.5 ms	1.074 s	1.072 s	1024
4	4 / 9600	10 K	128	1.207	8484	133 ms	139 ms	1.030 s	1.072 s	1024
2	6 / 38 400	38 400	1	2.755	37169	440 µs	3.1 ms	2.755 s	2.755 s	10240
2	6 / 38 400	38 400	1	0.276	37101	440 µs	3.1 ms	0.275 s	0.275 s	1024

ANNEX 2 : Integrated antenna Irradiation diagram

The following diagram highlights that the RF output level of the integrated antenna transceiver version is not homogeneous. The RF irradiation is modified by the integration of the transceiver in the host system, by the physical dimension and material of this host system. You must remember that the integrated antenna is dedicated to short range communication, and the range is closely linked to the equipment position.

WARNING

this diagram must not be used as a reference diagram. It is the result of an ADEUNIS integration. An integration of the transceiver in another system will generate a different irradiation diagram.

Irradiation digram ARF7151

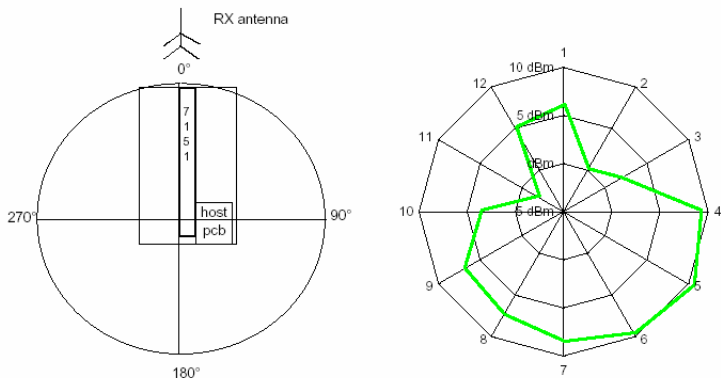

Installation TOP VIEW

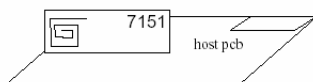
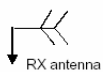

Installation Side view

ANNEX 3 : Alternative mounting

If the module cannot be plugged directly on the motherboard, it is possible to mount a connector. However, we do not recommend this use to keep the radio stability of the module.

Some references of connector:

Module header: Vertical Male header: Antelec ref. AM2D 200 26 6 G

Motherboard receptacle: Vertical Female receptacle (Through Hole): Antelec ref. AF2D 200 26 G

Right Angle Female receptacle (Through Hole): Antelec ref. AF2C 200 26 49 G

Vertical Female receptacle (Surface Mount): Antelec ref. AF2D 200 26 G CMS

Right Angle Female receptacle (Surface Mount): Antelec ref. F2C 200 026 G CMS

On request, the module could be shipped with the recommended connector.

ANNEX 4 : Firmware updates

Firmware	Updates
V0.08 /V0.09	S202 register added S204, preamble duration → the minimum preamble duration is 3ms for the radio rate 57 Kbit/s and 6ms for the 9.6 kbit/s
V1.00	S205 register added S210 600 and 1200 bps added S215 change default register value to 1 Create the 915 MHz version optimized for FCC Part 15.247 : S200 : 26 channel for 915MHz
V1.01	RS485 management Enhancement
V1.02	Radio calibration optimization
V1.03	Pin code added

Document	Updates
06-09-V9-PTR	Minor fixes
07-10-V10-PTR	Datasheet is 868Mhz specific (915Mhz not covered)
07-12-V11-ptr	Radio calibration duration worst cases is 90ms
08-07-V13-Imn	Pin code added